



**WORKWEAR  
OUTFITTERS®**

# CUSTOMIZATION GUIDE

DECORATE IT. MODIFY IT. CUSTOMIZE IT.



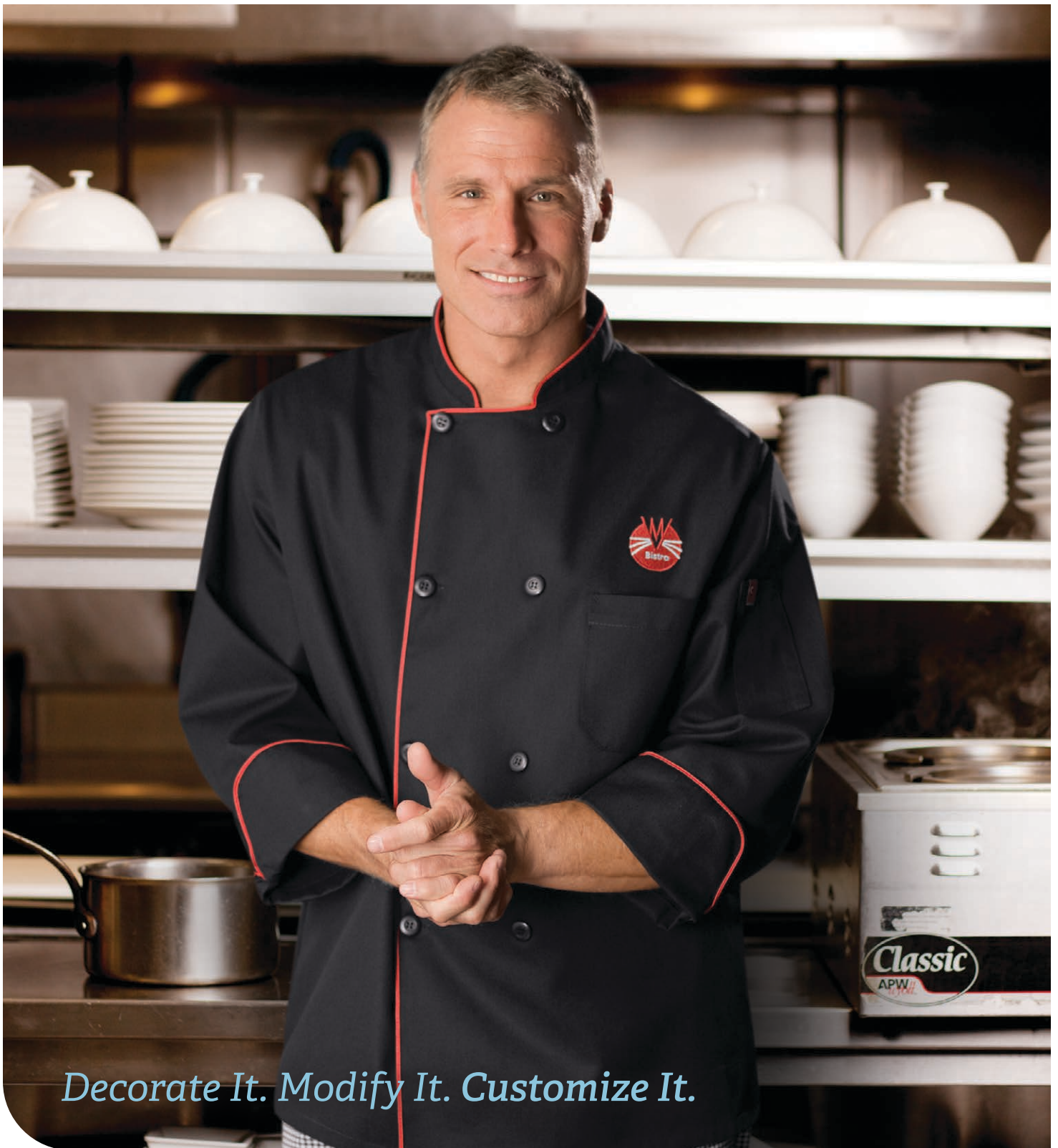

*Decorate It. Modify It. Customize It.*

## **YOUR COMPANY'S PERSONAL IMAGE**

We have taken the capability of creating customized uniform items and apparel to a new level. Our unique capabilities allow you to select stock apparel from our many brands and customize them to create uniforms that cater directly to your customer's needs.

No business tool impacts your company's image as powerfully as the right apparel and Workwear Outfitters provides the tools to set you apart from the competition.



# EMBROIDERY

## ACTIVITY: EL - EMBROIDER LOGOS / EH - EMBROIDER BALL CAPS

Embroidery is one of the first enhancements most customers look at when considering decoration of Workwear Outfitters' apparel. A logo announces to the world who you represent, and a strong first impression can make a big difference in business. Workwear Outfitters can handle all aspects of your embroidery needs. We offer a wide selection of thread colors shown on pages 14 - 15. If you need your logo digitized, we can handle that as well.



WS20KH

SP24OR

## HOW TO REQUEST A CUSTOM LOGO

- **CONTACT CUSTOMER SERVICE** for additional information on submitting new logo image artwork. 1-800-733-5271
- **FORMATS** - Acceptable formats for artwork of logo include: .TIF, .BMP, .JPG, or .EPS. Or, submit a previously digitized file (Tajima format preferred).
- **COLOR/THREAD LIMITATIONS** - Custom logos are limited to 15 colors.
- **SIZE** - A typical left or right chest location is about 2 1/2" x 3 1/2". Small detail in a logo design may require resizing or an adjustment so that detail can be seen. See page 5 for size guidelines on garments and locations.
- **TIMELINE** - If required, please allow up to 3 days to receive a sew-off of custom logos. Electronic proofs can be available in as few as 24 hours.



# EMBROIDERY LOCATIONS

Workwear Outfitters uses colorfast embroidery threads for all embroidery applications. These threads are also accepted by the industrial laundry industry. Using good laundry practices, as outlined in the "Red Kap Guide to Laundry Processing," will produce acceptable results with industrial processed garments. Because end use and processing requirements will vary, laundering a sample is recommended to determine the specific guidelines that work best in your situation.

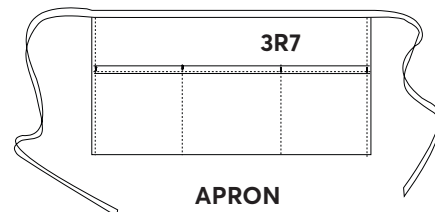
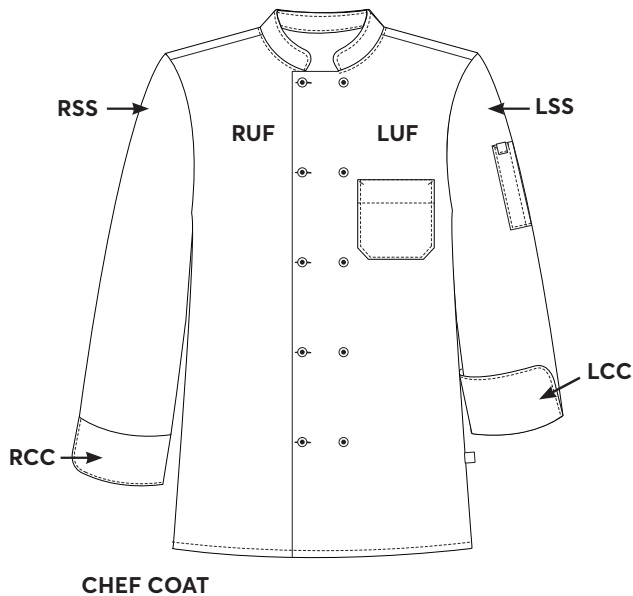
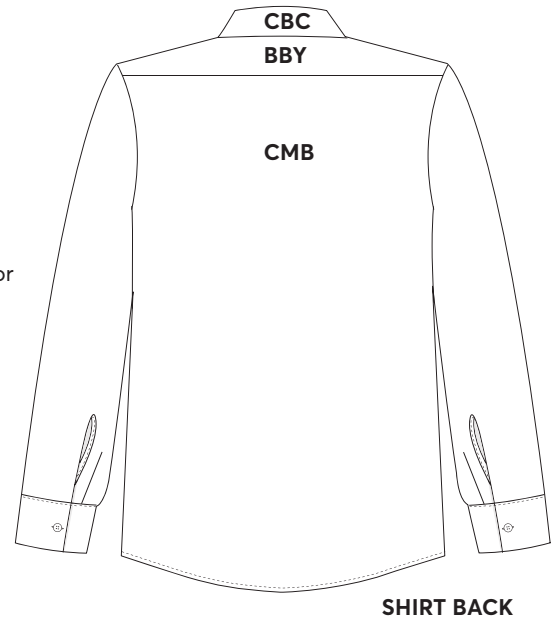
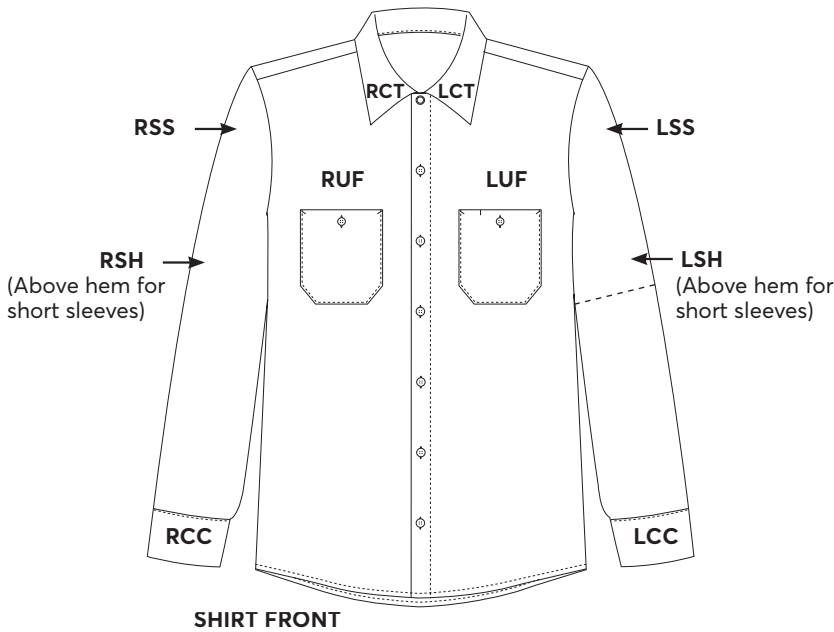

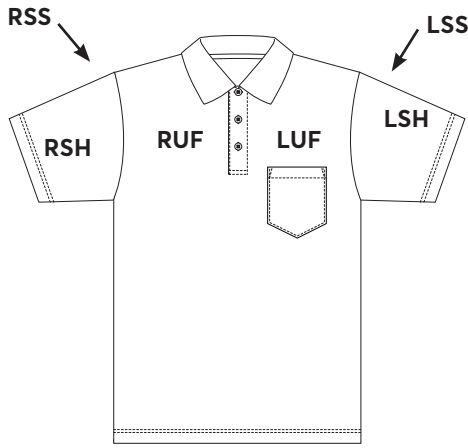

**POLO FRONT**



**POLO BACK**

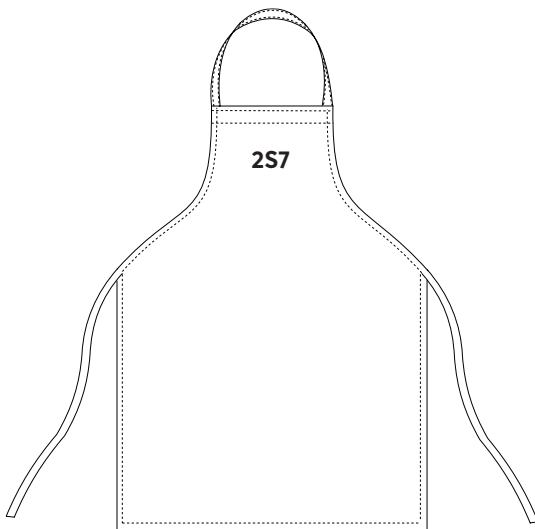

**APRON**

**\*USE ACTIVITY CODE: EH**

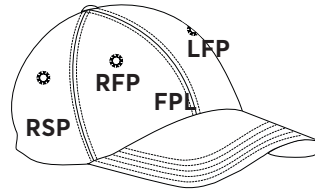

**BALL CAP FRONT**

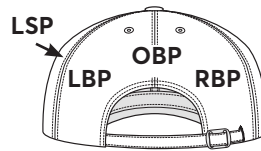

**BALL CAP BACK**

## EMBROIDERY CODES WITH SIZE GUIDELINES

All sizes below listed as inches.

<b>BBC</b> - Back, 1" Below Collar	1x4
<b>BBY</b> - Back Yoke	1½x4
<b>CBC</b> - Center Back Collar	1x1
<b>CMB</b> - Center Middle Back	10x10
<b>LCC</b> - Left Cuff Centered	1x3
<b>LCT</b> - Left Collar Tip	1x2
<b>LSH</b> - Left Short Sleeve at Hem	4x4
<b>LSS</b> - Left Sleeve at Shoulder	4x4
<b>LUF</b> - Left Upper Front	4 x 4
<b>RCC</b> - Right Cuff Center	1x3
<b>RCT</b> - Right Collar Tip	1x2
<b>RSH</b> - Right Short Sleeve at Hem	4x4
<b>RSS</b> - Right Sleeve at Shoulder	4x4
<b>RUF</b> - Right Upper Front	4 x 4
<b>2S7</b> - Middle Upper Front	3x3
<b>3R7</b> - Left Upper Front - Apron	3 x3

## EMBROIDERY GUIDELINES AND SUCCESS TIPS

- Placement and size can differ based on the garment they will be sewn on. These pages show placements and size guidelines for various garment types.
- To determine the best size and placement for embroidery, photocopy the logo to the desired size, cut it out and place it on the garment in various locations until the best size and location is determined.
- If grommets, eyelets or badges will be going on the same side of a garment as embroidery, be sure to leave the appropriate space for the badge when specifying embroidery location.

### DON'T SEE YOUR LOCATION LISTED?

Contact Customer Service. We have over 300 different embroidery locations across all garments, and one that will work for you.

## \*EMBROIDERY CODES FOR BALL CAPS (EH)

Use activity code EH

<b>*FPL</b> - Front Panel, Cap	2¼x4
<b>*LFP</b> - Left Front Panel, Cap	1x1½
<b>*LSP</b> - Left Side Panel, Cap	1x1½
<b>*OBP</b> - Over Back Panel, Cap	1¼x4
<b>*RFP</b> - Right Front Panel, Cap	1x1½
<b>*RSP</b> - Right Side Panel, Cap	1x1½



# STOCK EMBLEMS

## ACTIVITY: AM

Whether adding an embroidered "name" emblem, or an American flag, or one of your own emblems we will attach them all with expertise. Emblems supplied by our customers are kept in a secured area and applied at the time of order allowing the customer flexibility to decorate their garments with a variety of emblem placements.



**EM3323**  
American Flag with right star field and Gold Trim 3" x 1 7/8"



**EMR037**  
American Flag with left star field and Gold Trim 3 1/2" x 2"



**EM4914**  
American Flag with right star field — Grey 3 1/2" x 2"

## AMERICAN FLAG EMBLEMS

LOT #	BORDER	STAR FIELD	SIZE
EHP016	White	Left	1 3/4" x 1"
EM2437	White	Left	3 1/2" x 2"
EMR037	Gold	Left	3 1/2" x 2"
EMR1AF	Gold	Left	4" x 2 1/2"
EM3461	White	Right	3 1/2" x 2"
EM3323	Gold	Right	3" x 1 7/8"
EM4914	Grey	Right	3 1/2" x 2"

**THE US DEPARTMENT OF DEFENSE HAS THIS TO SAY REGARDING THE PROPER PLACEMENT OF THE AMERICAN FLAG ON UNIFORMS.**

"The regulation states that when authorized for application to the proper uniform the American flag patch is to be worn, right or left shoulder, so that "the star field faces forward, or to the flag's own right. When worn in this manner, the flag is facing to the observers right, and gives the effect of the flag flying in the breeze as the wearer moves forward. The appropriate replica for the right sleeve is identified as the "reverse side flag".



# EMBLEM EMBROIDERY

ACTIVITY: EM - EMBROIDER & ATTACH  
EE - EMBROIDER AND SELL LOOSE

The same font selections and sizes shown on the following pages can also be applied to emblems.  
See next page for color options and character limitations on emblems.



## SMALL EMBLEM

Shown Actual Size

### FONT SIZE:

Shown Actual Size

5/8" 15 mm

7 characters per line



## LARGE EMBLEM

Shown Actual Size

### FONT SIZE:

Shown Actual Size

5/8" 15 mm

10 characters per line

## EMBLEM EMBROIDERY CONTINUED...

### EMBLEM COLORS AND SIZES



White,  
White Trim  
**LARGE:**  
EMR2WW  
**SMALL:**  
EMR1WW

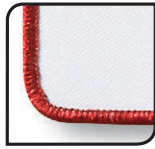

White,  
Red Trim  
**LARGE:**  
EMR2WR  
**SMALL:**  
EMR1WR



White,  
Blue Trim  
**LARGE:**  
EMR2WB  
**SMALL:**  
EMR1WB



White,  
Navy Trim  
**LARGE:**  
EMR2WN  
**SMALL:**  
EMR1WN



White,  
Black Trim  
**LARGE:**  
EMR2WK  
**SMALL:**  
EMR1WK



Grey,  
Black Trim  
**LARGE:**  
EMR2GN  
**SMALL:**  
EMR1GN

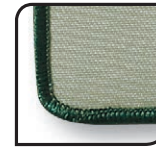

Light Green,  
Green Trim  
**LARGE:**  
EMR2GG  
**SMALL:**  
EMR1GG



Tan,  
Black Trim  
**SMALL:**  
EMR1TB

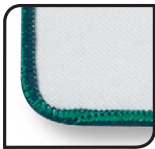

White,  
Green Trim  
**SMALL:**  
EMF1GR



Navy,  
White Trim  
**LARGE:**  
EMR2NW



Black, Black  
**LARGE:**  
EMR2BB  
**SMALL:**  
EMR1BA



Grey Diamond  
Plate Pattern,  
Grey Trim  
**SMALL:**  
EM4002



Grey Diamond  
Plate Pattern,  
Grey Trim  
**LARGE:**  
EM4108

### APPROXIMATE CHARACTER LIMITS FOR SMALL AND LARGE NAME EMBLEMS

	B08	B12	B15	B18	B25
SMALL NAME EMBLEM	11	8	7	5	4
LARGE NAME EMBLEM	14	10	9	7	5
	S08	S12	S15	S18	S25
SMALL NAME EMBLEM	15	9	8	6	n/a
LARGE NAME EMBLEM	20	12	11	8	5
	R08	R12	R15	R18	R25
SMALL NAME EMBLEM	11	7	6	5	3
LARGE NAME EMBLEM	15	10	8	6	4
	T08	T12	T15	T18	T25
SMALL NAME EMBLEM	14	9	7	5	n/a
LARGE NAME EMBLEM	18	12	10	7	4

**NOTE:** Lettering that drops below the horizon line cannot be completed for two line application on S25 and T25 lettering on the large emblem.



# NAME STRIPS & NAME BADGES

## ACTIVITY: 4D (STRIPS) / EM (BADGES)

- Name Strips and Name Badges typically have finished sizes of 1" x 6"
- Name Strips have a fused back with clean folded fabric edges
- Name Badges have a color-matched merrowed edge
- 1" pant stripes can be cut to 6" and used for name strips

### 1" NAME STRIP COLORS - NON FR



Heather Grey 1" ES01GH

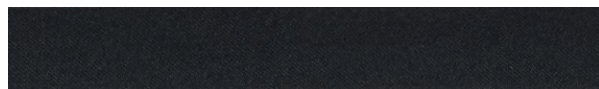

Black 1" ES01BK



Dark Navy 1" ES01DN



Charcoal 1" ES01CG

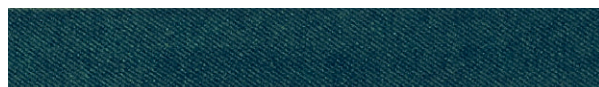

Spruce Green 1" ES01SG



Red 1" ES01RD



Burgundy 1" ES01MR

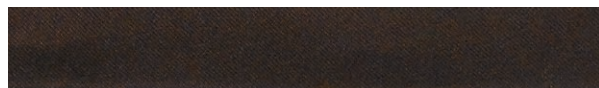

Brown 1" ES01BR

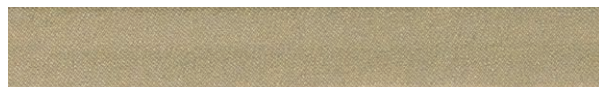

Khaki 1" ES01ST



Royal Blue 1" ES01RB

### NAME EMBLEMS OR BADGES / ACTIVITY: 4D

(not actual size)



EMB05W - 1" X 5", NAVY / NAVY



EMB18W - 1" X 5", BLACK / BLACK



EMB21W - 1.25" X 5", NAVY / NAVY



EMB23W - 1.25" X 5", BLACK / BLACK



EMB22W - 1" X 6", MIDNIGHT NAVY / MIDNIGHT NAVY



EMB25W - 1" X 5", NAVY / WHITE BORDER



EMB28W - 1" X 5", ROYAL BLUE / ROYAL BLUE

Example of merrowed edge used on Name Emblems/ Badges



# DIRECT EMBROIDERY

## ACTIVITY: ED

The fonts shown are offered for direct embroidery, with several sizes in each (3/8"- 1"). Embroider text directly on a garment (ED), an emblem (EM), or on a name strip (4D). This option is most often used for names, titles, accredits, etc. and can be done without the need for digitization.

### NOTES ABOUT EMBROIDERING AND FONTS:

- Multiple lines of type can be added to a garment.
- Collar tip and cuff embroidery locations require an 8mm font and are limited to three characters.
- Include spaces and punctuation when counting characters per line.
- Specify if all CAPS are needed. Using all caps will reduce the number of characters per line.  
***The character counts listed below are based on lower case letters.***

*Please note: **Brush Script** and **Athletic Swoosh** are not recommended for ALL CAP needs, and should be used with both upper and lowercase letters.*

- **NAVY NAMETAG** font is only offered in all capital letters and at 12mm size, as it is used almost exclusively on 1" tall name tapes and emblems.
- The special characters offered (#, \$, ", etc) are not the same between fonts. *For information regarding availability of special characters, please contact a customer service representative.*

## FONTS, SIZES AND CHARACTER COUNTS

SIZES	FONTS				
	SMALL BLOCK	BRUSH SCRIPT	ATHLETIC SWOOSH	CENTURY MEDIUM	NAVY NAMETAG
	ORDER CODES	ORDER CODES	ORDER CODES	ORDER CODES	ORDER CODES
8mm (3/8")	<b>B08</b>	<b>T08</b>	<b>S08</b>	<b>R08</b>	-
12mm (1/2")	<b>B12</b>	<b>T12</b>	<b>S12</b>	<b>R12</b>	<b>NNV</b>
15mm (5/8")	<b>B15</b>	<b>T15</b>	<b>S15</b>	<b>R15</b>	-
18mm (3/4")	<b>B18</b>	<b>T18</b>	<b>S18</b>	<b>R18</b>	-
25mm (1")	<b>B25</b>	<b>T25</b>	<b>S25</b>	<b>R25</b>	-
	Upper and Lower case usage = OK	ALL CAPS NOT recommended	ALL CAPS NOT recommended	Upper and Lower case usage = OK	ALL CAPS only. Lower case = n/a
	CHARACTERS PER LINE	CHARACTERS PER LINE	CHARACTERS PER LINE	CHARACTERS PER LINE	CHARACTERS PER LINE
8mm	<b>22</b>	<b>28</b>	<b>30</b>	<b>23</b>	-
12mm	<b>16</b>	<b>18</b>	<b>19</b>	<b>15</b>	<b>16</b>
15mm	<b>14</b>	<b>15</b>	<b>17</b>	<b>13</b>	-
18mm	<b>11</b>	<b>11</b>	<b>12</b>	<b>10</b>	-
25mm	<b>8</b>	<b>7</b>	<b>8</b>	<b>6</b>	-

# FONT OPTIONS

Shown below are all the available characters in the 5 fonts offered.

Block Small VF

**A B C D E F G H I J K L M N**  
**O P Q R S T U V W X Y Z**  
**a b c d e f g h i j k l m n**  
**o p q r s t u v w x y z**  
**0 1 2 3 4 5 6 7 8 9**  
**! " # \$ % & ' ( ) \* + , - . / : ; \**

Brush Script VF

*A B C D E F G H I J K L M N*  
*O P Q R S T U V W X Y Z*  
*a b c d e f g h i j k l m n*  
*o p q r s t u v w x y z*  
*0 1 2 3 4 5 6 7 8 9*  
*! # \$ % & ' ( ) \* + , - . / : ; \*

- NOT RECOMMENDED FOR ALL CAP NEEDS. SHOULD BE USED WITH BOTH UPPER AND LOWERCASE LETTERS. -

Athletic Swoosh

*A B C D E F G H I J K L M N*  
*O P Q R S T U V W X Y Z*  
*a b c d e f g h i j k l m n*  
*o p q r s t u v w x y z*  
*0 1 2 3 4 5 6 7 8 9*  
*! " # \$ % & ' ( ) \* + , - . / : ; < > ? @ \_ \ ^*

- NOT RECOMMENDED FOR ALL CAP NEEDS. SHOULD BE USED WITH BOTH UPPER AND LOWERCASE LETTERS. -

Century Medium

**A B C D E F G H I J K L M N**  
**O P Q R S T U V W X Y Z**  
**a b c d e f g h i j k l m n**  
**o p q r s t u v w x y z**  
**0 1 2 3 4 5 6 7 8 9**  
**! " # \$ % & ' ( ) + , - . / : ; < > ? @ \ ^**

Navy Nametag Caps

**A B C D E F G H I J K L M**  
**N O P Q R S T U V W X Y Z**

- ONLY OFFERED IN ALL CAPITAL LETTERS AND AT 12MM SIZE. -



# FONT/THREAD EXAMPLES

## ACTIVITY: 4D (STRIPS) / EM (BADGES)

On this page and the next are a variety of examples of embroidered fonts and thread colors, all at size B12, and shown on either Name/Rank Strip Name Tape or Name/Rank Badge Emblems.  
*See notes below each for specifics shown.*

### FONT: BLOCK SMALL

TOP: ALL CAPITALIZED LETTERS; BOTTOM: UPPER AND LOWERCASE LETTERS.



EMB30W - NAVY



EHP324 - NAVY

### FONT: BRUSH SCRIPT

UPPER AND LOWERCASE LETTERS.



EHP360 - MIDNIGHT NAVY

### FONT: ATHLETIC SWOOSH

UPPER AND LOWERCASE LETTERS.



EMB30W - NAVY

FONT/THREAD EXAMPLES CONTINUED...

---

**FONT: CENTURY MEDIUM**

TOP: ALL CAPITALIZED LETTERS; BOTTOM: UPPER AND LOWERCASE LETTERS.



EMB32W - BLACK



EHP361 - BLACK

---

**FONT: NAVY NAMETAG CAPS**

ALL CAPITALIZED LETTERS (ONLY).













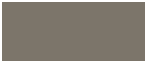































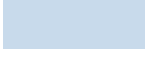









































ES01ST - KHAKI

# THREAD COLOR OPTIONS

We will be happy to match your Pantone® supplied colors to American Efrid Signature thread. If a color cannot be matched we will contact you with alternative suggestions.

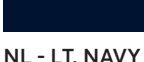
							
<b>WH - WHITE</b> 50081	<b>V1 - VISOR GOLD</b> 50566	<b>M5 - SUNSHINE</b> 50594	<b>SU - SUNBURST</b> 50533	<b>2N - ANTIQUE GOLD</b> 50524	<b>P4 - PUMPKIN</b> 50367	<b>CR - MARASCHINO</b> 50059	<b>RR - RADIANT RED II</b> 50810
							
<b>XA - IVORY</b> 50396	<b>8T - GOLD</b> 51354	<b>8J - GOLDENROD</b> 50364	<b>YE - YELLOW</b> 50532	<b>R8 - RATTAN</b> 50402	<b>8V - PUMPKIN II</b> 50737	<b>8D - SCARLET</b> 50074	<b>PS - PASSION</b> 50261
							
<b>IV - IVORY</b> 50780	<b>G5 - GOLD #23</b> 50882	<b>ST - STAR GOLD</b> 50351	<b>LO - TOBOGGAN</b> 50751	<b>XC - DARK KHAKE</b> 50092	<b>OP - ORANGE POPPY</b> 50565	<b>RD - MI ARTILLERY</b> 50018	<b>BQ - BISQUE</b> 50155
							
<b>XB - CHAMPAGNE</b> 50054	<b>8R - KHAKE</b> 50782	<b>LG - LIBERTY GOLD</b> 50026	<b>BN - RANCHO BROWN</b> 50041	<b>XD - CHOCOLATE</b> 50411	<b>8Q - DK. ORANGE</b> 50730	<b>1B - CARDINAL</b> 50588	<b>ZP - PINK</b> 50101
							
<b>9X - SEASHELL</b> 50408	<b>LA - LEMONADE</b> 50023	<b>GD - ROYAL GOLD</b> 50019	<b>PE - PENNY</b> 50386	<b>NU - NUTMEG</b> 50635	<b>5K - PAPRIKA</b> 50370	<b>WF - WILDFIRE</b> 50562	<b>LV - CACHET</b> 50048
							
<b>E6 - OFF WHITE</b> 50091	<b>CN - CANARY</b> 50362	<b>4T - MARIGOLD</b> 50027	<b>MT - GOLD (METALLIC)</b> 51000	<b>XE - LIGHT COCOA</b> 50412	<b>OR - PAPRIKA #2</b> 50600	<b>MR - GARNET #2</b> 50718	<b>9E - PLUM</b> 50540
							
<b>MS - SILVER</b> 51001	<b>1Y - MOON BEAM</b> 50522	<b>MU - MUSTARD</b> 50383	<b>9T - COPPER</b> 50378	<b>C6 - BROWN</b> 50414	<b>SR - SPANISH RED</b> 50020	<b>RT - RUSSET</b> 50115	<b>PR - DK PURPLE #2</b> 50756
							
<b>EU - ECRU</b> 50398	<b>9H - SUNFLOWER</b> 51533	<b>NE - NECTOR</b> 50360	<b>XX - BRASS GOLD</b> 50596	<b>BY - BURLY BROWN</b> 50577	<b>A8 - TERRA COTTA</b> 50394	<b>8E - CAROLINA RED</b> 50147	<b>DP - DEEP PURPLE</b> 50768
							
<b>TP - TAUPE BEIGE</b> 50039	<b>FL - FLUORESCENT YELLOW</b> 50024	<b>B7 - BUTTER-SCOTCH</b> 50604	<b>8L - GOLD</b> 50555	<b>DB - WALNUT</b> 50042	<b>E7 - CANDY APPLE</b> 50082	<b>WN - MAROON</b> 50465	<b>XG - EASTER PURPLE</b> 50654
							
<b>8B - BEIGE</b> 50008	<b>YL - MIMOSA</b> 50025	<b>9N - BUTTER</b> 50521	<b>OD - OLD GOLD</b> 50860	<b>SP - SPICE</b> 50621	<b>Q6 - RED PEPPER</b> 50098	<b>NM - INTENSE MAROON</b> 50627	<b>1Q - EGGPLANT</b> 50626
							
<b>3G - GLOW</b> 50350	<b>DF - DAFFODIL</b> 50087	<b>9W - MARIGOLD</b> 52416	<b>8P - HONEY GOLD</b> 50642	<b>RS - RUST</b> 50377	<b>FX - FOXY RED</b> 50141	<b>PK - PERISAN ROSE</b> 50021	<b>8K - PURPLE TWIST</b> 50548

## THREAD COLOR OPTIONS (CONTINUED)

# 1-COLOR CUT TRANSFERS

ACTIVITY: VY

---

Minimum  
Order Qty: 1 pc

Maximum Width: 10"  
(actual width depends  
on placement)

Wash: HW and LS



## VINYL COLORS



Black - BK

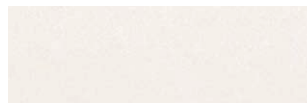

White - WH



Yellow-Gold - YG



Reflective Silver - RS

**1-COLOR CUT TRANSFERS, EXAMPLES:**

**LETTERING AND WORDS CAN BE CREATED WITH DESCRIPTIONS AND MEASUREMENT, I.E.:  
3" TALL BLOCK LETTERS, ALL CAPS, "SECURITY". MORE EXAMPLES BELOW.**



White vinyl  
(on dark background)



Silver Reflective vinyl  
(on light background)



Silver Reflective vinyl  
(on dark background)



Black vinyl  
(on light background)



Yellow-Gold vinyl  
(on dark background)



White vinyl  
(on dark background)

**DESIGN CONCEPT EXAMPLES FOR 1-COLOR CUT TRANSFERS:**



Black vinyl



Black vinyl



Black vinyl



Silver Reflective vinyl



Black vinyl



White vinyl  
(on dark background)



Silver Reflective vinyl



Yellow-Gold vinyl

**FOR MORE INFORMATION, CONTACT A CUSTOMER SERVICE REPRESENTATIVE AT 1-800-733-5271, OR VISIT [WWW.WWOF.COM](http://WWW.WWOF.COM).**



# REFLECTIVE STRIPING

Enhanced visibility can be critical when working in high-traffic areas, on construction sites or around equipment operation. Adding reflective striping to your uniform can make a life-saving difference. Select from the many trim widths, colors and placements to make your enhancements have the highest impact. These distinctive stripings can be added to most garments. Flame-resistant striping is also available. The garments and striping you select should depend on the end use requirements.

With a few exceptions, stripes shown above the waist can be applied to a shirt, jacket or coverall. Stripes shown below the waist can apply to a pant, short, or coverall. The specific details of a garment, like the size of a pocket, the placement of closures, an emblem or an additional pocket, may dictate a slight change in the placement from what is shown in these images.

- Striping applied post-manufacturing will always go around a pocket or emblem. Pockets cannot be removed for reflective trim application.
- Stripes on a waistband will be moved up or down if the waistband has elastic sections.

ST52SV



PC20NV



### REFLECTIVE STRIPING LOCATIONS

STRIPE CODES	LOCATION DESCRIPTION	FRONT	BACK
<b>HUF</b>	HORIZONTAL UPPER FRONT	•	
<b>STS</b>	SHOULDER TO SHOULDER		•
<b>HUB</b>	HORIZONTAL UPPER BACK		•
<b>DHB</b>	DOUBLE HORIZONTAL BACK		•
<b>BSB</b>	BOTH SLEEVES BICEP	•	•
<b>HUP</b>	HORIZONTAL UNDER POCKETS	•	
<b>LMB</b>	LOWER MID BACK		•
<b>AAC</b>	ALL AROUND COVERALL	•	•
<b>BSF</b>	BOTH SLEEVES FOREARMS	•	•
<b>JWB</b>	JACKET/COVERALL WAISTBAND	•	•
<b>LSC</b>	LONG SLEEVE CUFF	•	•
<b>BLT</b>	BOTH LEGS THIGH	•	•
<b>PLK</b>	PANT LEG KNEE	•	•
<b>BLC</b>	BOTH LEGS CALF	•	•
<b>PLC</b>	PANT LEG CUFF	•	•



### REFLECTIVE STRIPING LOCATIONS

STRIPE CODES	LOCATION DESCRIPTION	FRONT	BACK
<b>SUS</b>	AROUND WAIST, 2 PIECES OVER SHOULDERS AND 2 PIECES UNDER POCKETS	•	•
<b>SSC</b>	SHORT SLEEVE CUFF	•	•



#### ANSI COMPLIANT STRIPING

The stripe configurations shown here are not necessarily ANSI compliant. To provide guidance for the protection of all those exposed to the hazards of limited visibility, the American National Standards Institute, Inc. (ANSI), approved ANSI/ISEA 107-2015, the American National Standard for High-Visibility Safety Apparel. ANSI/ISEA 107-2015 establishes design, material, photometric and physical performance requirements, care labeling and marking rules for high visibility garments.

End users should conduct a hazard assessment in order to select garments with the proper type, class and design placement for their work environment. Please refer to ANSI/ISEA 107-2015 for further information.



### REFLECTIVE STRIPING LOCATIONS

STRIPE CODES	LOCATION DESCRIPTION	FRONT		BACK	
		FRONT	BACK	FRONT	BACK
<b>LST</b>	LONG SLEEVE SHOULDER TO CUFF	•	•		
<b>FXB</b>	FULL X BACK - OK WITH SUSPENDERS			•	•
<b>OSW</b>	SIDE SEAM TO WAIST	•	•		

LST



OSW

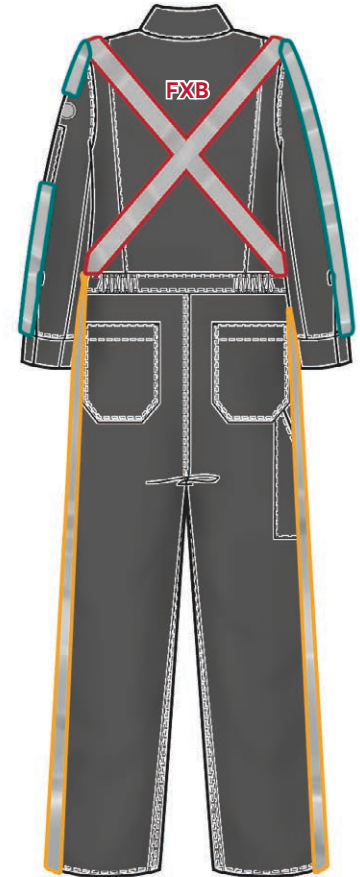

### REFLECTIVE STRIPING LOCATIONS

STRIPE CODES	LOCATION DESCRIPTION	FRONT		BACK	
		FRONT	BACK	FRONT	BACK
<b>SUP</b>	AROUND WAIST AND 2 PIECES OVER SHOULDERS	•	•		
<b>CBX</b>	CENTER BACK X-12" STRIPES			•	•



SST

SUP

SUP

AAS



CBX

### REFLECTIVE STRIPING PACKAGES

Many package options already exist for various stripe configurations on shirts, jackets, coveralls, and pants. Contact a (CSR) Customer Service Representative for the stripe combination you are looking for, or peruse the next several pages for some of the most frequently purchased package configurations.

# REFLECTIVE STRIPING PACKAGES

Many package options for reflective striping already exist for shirts, jackets, coveralls and pants. On the next several pages we're showing a collection of the most popular packages to help identify one that will work for you. As a package these applications will carry a lower overall price than the individual locations ordered together.



## PANTS / COVERALLS

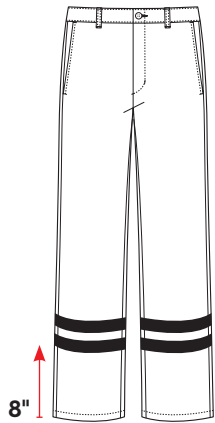

DM7

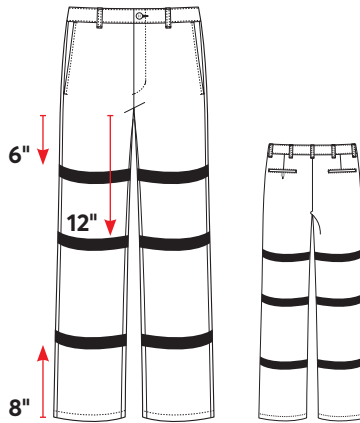

D98

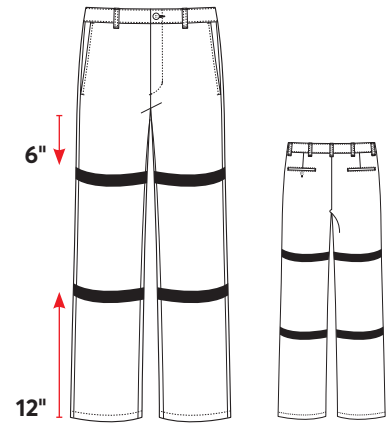

DLK

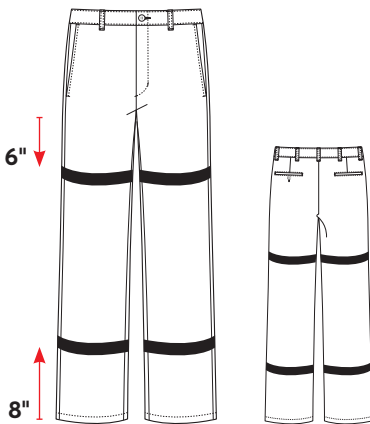

DB2

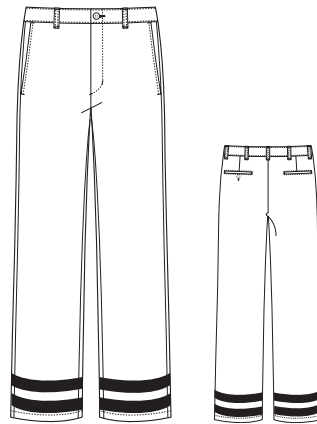

D75

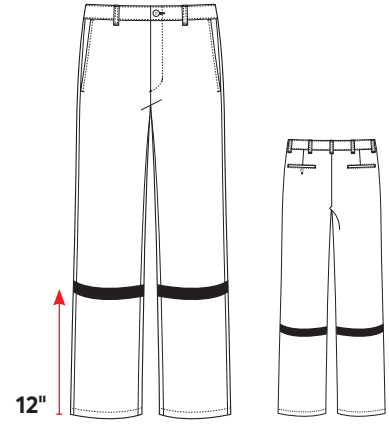

5W7

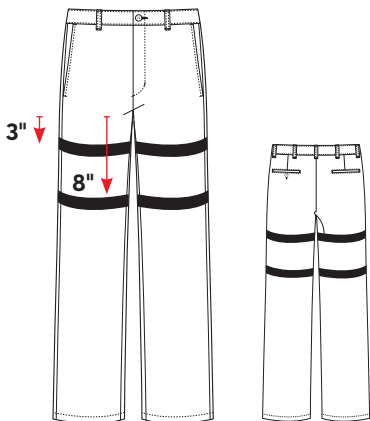

DL2

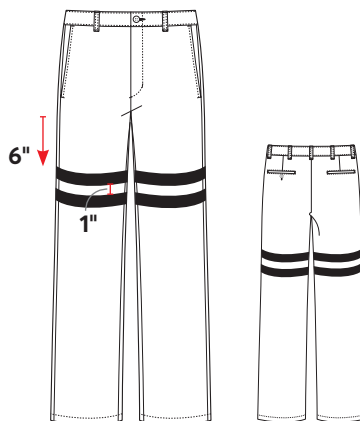

DD4

All illustrations are shown on generic garment images.



## SHIRTS / COVERALLS / JACKETS



**DU1**



**5N8**



**D71**



**D96**



**D93**



**DN3**



**D26**



**DB8**



Inquire with your customer service representative if you need specific information or measurements on any of the packages shown. ANY changes to what is shown here will constitute a new package and a new price.

*All illustrations are shown on generic garment images.*



SHIRTS / COVERALLS / JACKETS CONTINUED...



6K7



DE2



DQ4



FOR



FXO



All illustrations are shown on generic garment images.



# COVERALLS

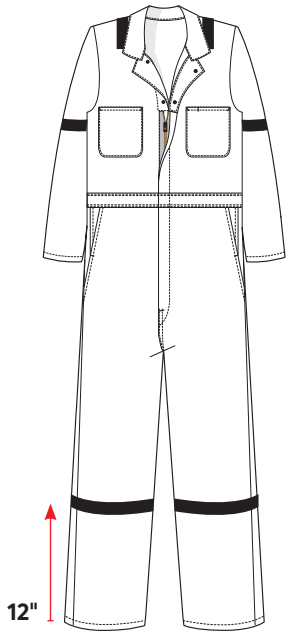

D35

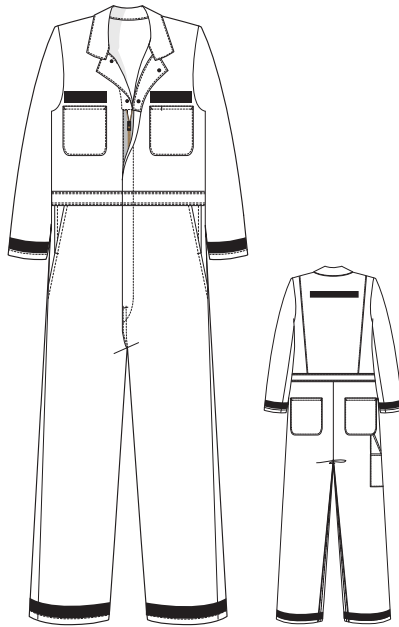

LPF

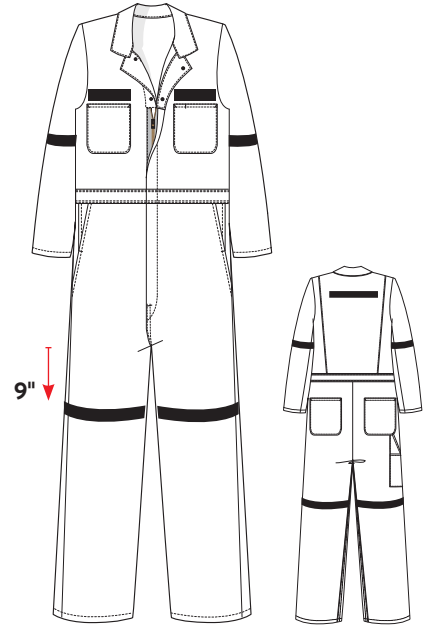

D92

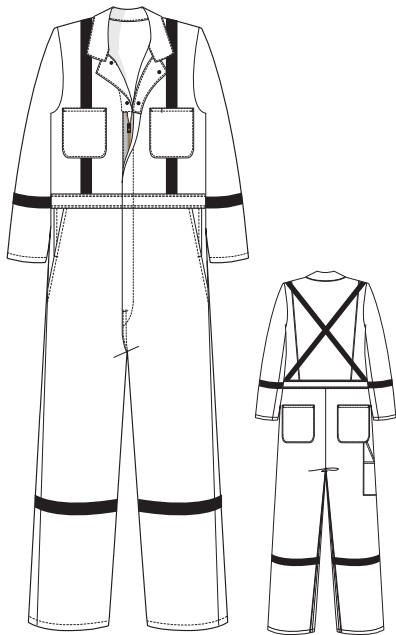

D36

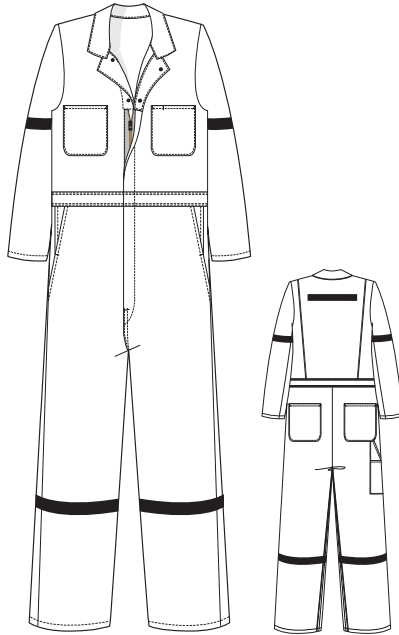

DY8

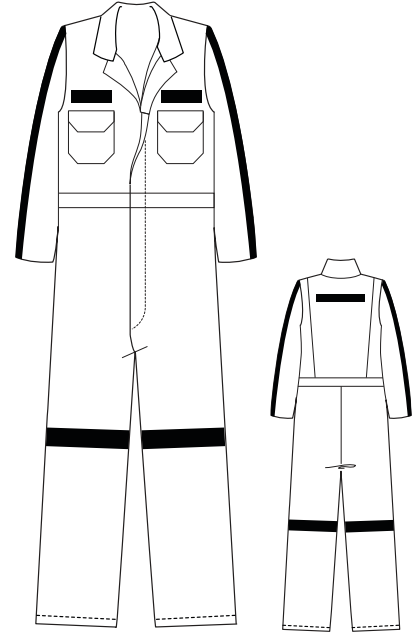

DQ1

All illustrations are shown on generic garment images.



## COVERALLS CONTINUED...

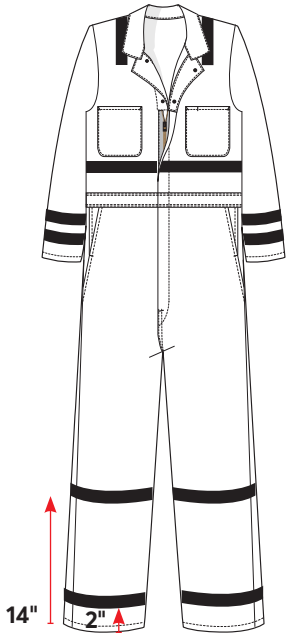

DC4

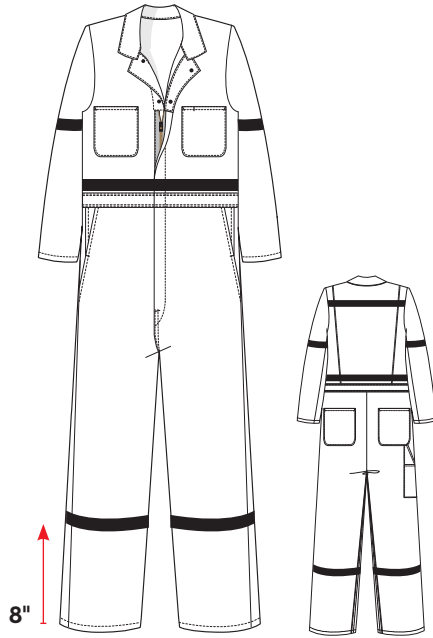

DN6

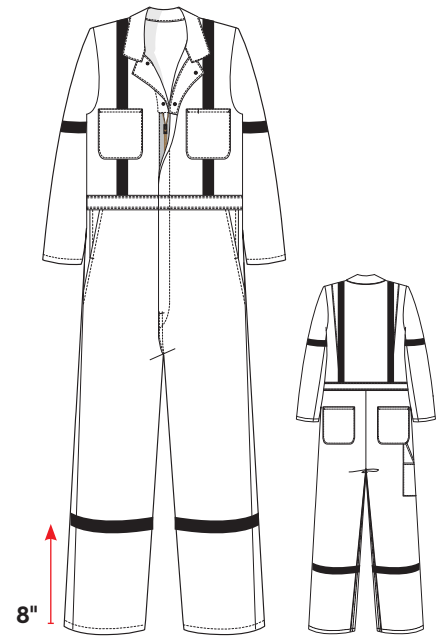

DK8

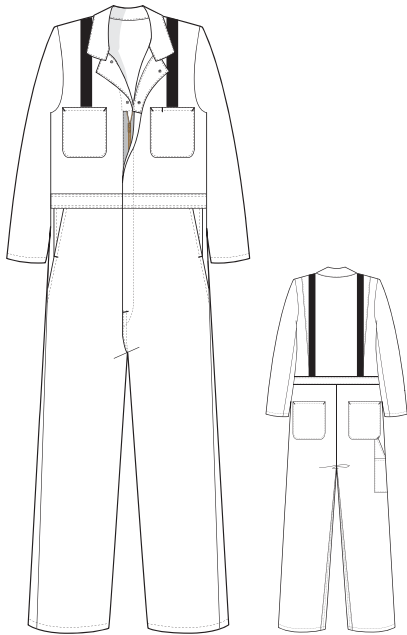

SFB

### DON'T SEE YOUR LOCATION LISTED?

Contact Customer Service. We have many more Striping locations across all garments, and one that will work for you.

*All illustrations are shown on generic garment images.*

# REFLECTIVE TRIM

There are several color options and widths of reflective trims that can be selected for attachment to your garments. Ours are divided into four categories: FR – Industrial Wash, FR – Home Wash, Industrial Wash, and Home Wash. Many stripe styles are available in one or more of these categories; however, prices will vary depending on the trim and locations selected. Please be sure to select the correct trim.



## FR/IL - FLAME RESISTANT/ INDUSTRIAL LAUNDRY FRIENDLY



Activity: S1 Component: EH5215 Description: 1" SILVER ▲

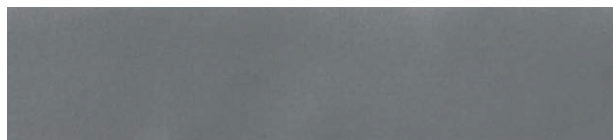

Activity: 1J Component: EH3207 Description: 2" SILVER ▲



Activity: 4B Component: ESRTOR  
Description: 2" ORANGE/ 3/4" SILVER/ORANGE ▲



Activity: 1B Component: EH5283  
Description: 2" YELLOW/ 3/4" SILVER/YELLOW ▲



Activity: Y4 Component: EH5208  
Description: 2 1/2" YELLOW/ 1" SILVER/YELLOW  
Wash in Light Soil Formula ▲



Activity: 5M Component: EH5386  
Description: 2 1/2" YELLOW/ 1 1/2" SILVER/YELLOW ▲



## FR/HW - FLAME RESISTANT/HOME WASH



Activity: S2 Component: EH5216 Description: 2" SILVER ▲



Activity: O1 Component: EH5210 Description: 1" ORANGE ▲



Activity: Y1 Component: EH5203 Description: 1" YELLOW ▲



Activity: 1N Component: EH5204 Description: 2" YELLOW ▲



Activity: Y3 Component: EH5207  
Description: 2" YELLOW/ 3/4" SILVER/YELLOW ▲

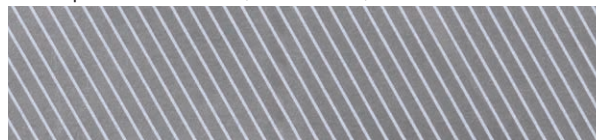

Activity: HT Component: EH3321  
Description: 2" SEGMENTED SILVER ▲



Activity: HK Component: EH3323  
Description: 2" SEGMENTED YELLOW/ 3/4" SILVER/YELLOW ▲



Codes with red symbols indicate reflective trims are (FR) flame-resistant.



(NOT SHOWN ACTUAL SIZE)



### IL - INDUSTRIAL LAUNDRY



Activity: 4C Component: EH5279 Description: 1/2" SILVER



Activity: 1P Component: EH5277 Description: 1" SILVER



Activity: G2 Component: EH5276 Description: 2" SILVER



Activity: 1K Component: EH5430  
Description: 1 1/2" YELLOW/ 1/2" SILVER/YELLOW



Activity: 3N Component: EH5221  
Description: 2" YELLOW/ 3/4" SILVER/YELLOW



Activity: 1E Component: EH5282  
Description: 2 1/2" YELLOW/ 1/2" SILVER/YELLOW



Activity: 4M Component: EH5284  
Description: 2 1/2" YELLOW/ 1 1/2" SILVER/YELLOW



Activity: OV Component: EH5280  
Description: 1 1/2" ORANGE/ 1/2" SILVER/ORANGE



Activity: 1Q Component: EH5278  
Description: 2 1/2" ORANGE/ 1/2" SILVER/ORANGE

(NOT SHOWN ACTUAL SIZE)



### HW - HOME WASH



Activity: GV Component: EH5226 Description: 1" SILVER

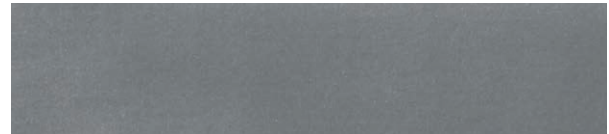

Activity: 1O Component: EH5225 Description: 2" SILVER



Activity: YV Component: EH5281  
Description: 1 1/2" YELLOW/ 1/2" SILVER/YELLOW

(NOT SHOWN ACTUAL SIZE)

# LOCATION CODE GUIDELINES FOR FIRE SERVICES / SECURITY UNIFORMS

LOCATION CODES: VARIOUS (SEE BELOW) / ACTIVITY CODES: TYPICALLY, AM (ATTACH EMBLEM), EM (EMBROIDER & ATTACH EMBLEM), OR 4D (EMBROIDER & ATTACH NAME STRIP/EMBLEM)

## TO ADD AN EMBLEM OR EMBROIDERY TO RT SLEEVE

- RS8** - 1/2" below shoulder seam, centered
- RSS** - 1" below shoulder seam, centered
- 1C4** - 1-1/2" below shoulder seam, centered
- R2S** - 2" below shoulder seam, centered

Examples Shown:

**AM\_1C4\_EM3323** (flag)

- Attach Emblem
- 1-1/2" below shoulder, centered, right sleeve
- American Flag with right star field, gold trim

**EM\_2L7** (top/name)\_**EMB30W** (Navy name badge)

- Embroider & Attach Emblem
- Directly above existing CZ, right chest
- Directly above right chest pocket, centered

**EM\_RN1** (bottom/rank)\_**EMB30W** (Navy name badge)

- Embroider & Attach Emblem
- Directly above right chest pocket, centered

## TO MATCH A RIGHT CHEST CZ PLACEMENT WITH AN EXISTING LEFT CHEST PLACEMENT

**1F7** - RT chest aligns with LT chest, at BOTTOM of decoration

**1B6** - RT chest centers on the LT chest decoration

## TO ADD A 2<sup>ND</sup> EMBLEM/STRIP ABOVE THE FIRST (TO RIGHT CHEST)

**2L7** - Directly above existing CZ

**RF8** - 1/8" above existing CZ

## TO ADD A NAME EMBLEM/STRIP ON RIGHT CHEST

**RN1** - Directly above pocket, centered

**2Q1** - 1/8" above pocket, centered

**RUF** - 1" above pocket, centered

## NAME AND/OR RANK STRIPS / ACTIVITY: 4D

COLOR-MATCHED FABRIC STRIP, sewn on all four sides



**EHP324** - NAVY



**EHP360**  
**MIDNIGHT**  
**NAVY**



**EHP361**  
**BLACK**



Example garment shown: **FSCONV**

## LOCATION CODE GUIDELINES FOR FIRE SERVICES/SECURITY UNIFORMS CONTINUED...

LOCATION CODES: VARIOUS (SEE BELOW) / ACTIVITY CODES: TYPICALLY, AM (ATTACH EMBLEM) OR EM (EMBROIDER & ATTACH EMBLEM)

### NAME AND/OR RANK BADGES / ACTIVITY: EM

PRE-MADE BADGE/EMBLEM, sewn on all four sides



EMB30W - NAVY



EMB31W  
MIDNIGHT  
NAVY



EMB32W  
BLACK



Edge

### TO ADD AN EMBLEM OR EMBROIDERY TO LT SLEEVE

**LS8** - 1/2" below shoulder seam, centered

**LSS** - 1" below shoulder seam, centered

**1B1** - 1-1/2" below shoulder seam, centered

**L2S** - 2" below shoulder seam, centered

Example Shown:

**AM\_1B1**

- Attach Emblem
- 1-1/2" below shoulder, centered, left sleeve

### TO PLACE AN EMBLEM (BADGE TYPE) ON LEFT CHEST

**3E4** - Centered above pocket and covering name badge

- OR -

**3R6** - to Remove badge tab (if emblem size does not cover existing badge tab)

### TO ADD A 2<sup>ND</sup> EMBLEM/ STRIP ABOVE THE FIRST (ON LEFT CHEST)

**LF8** - 1/8" above existing CZ

### TO ADD A NAME EMBLEM/ STRIP ON LEFT CHEST

**LN1** - Directly above pocket, centered

**2M1** - 1/8" above pocket, centered

**LUF** - 1" above pocket, centered

Example garment shown: **FSCONV**



# EPAULETS

**ACTIVITY: AE - ADD EPAULETS / FM\_LRE - REPLACE EPAULETS**

Epaulets and pocket flaps can quickly turn a generic garment into one that speaks directly to a specific job function. Whether using contrasting color combinations or matching trims these shirts can dress employees from security to parking attendants, bellmen and doormen.



White - **EERTWH**



Red - **EERTRD**



Black - **EERTBK**



Navy - **EERTNV**



Charcoal - **EERTCH**

Epaulets are attached at sleeve set seam and end 1" from the collar band.

Fabrics are 65/35 poplin and match the fabrics and colors of our SP14 industrial workshirt.

# EPAULETS, POCKET FLAPS, AND BADGE TABS

**ACTIVITY: AE - ADD EPAULETS / FM\_LRE - REPLACE EPAULETS  
AF - ADD FLAPS / FM\_LRF - REPLACE FLAPS / BT - ATTACH BADGE TAB**

Select from many color options to upgrade your shirts with contrasting pocket flaps and epaulets. Available in solid shades, these options can make your uniforms command attention and be noticed.

The shirt below shows other customized options that can be added to your shirt. Modify your garments to fit your specific needs.



**COLLAR EYELETS**  
CODE: EV\_LRC



**BADGE TAB - METAL EYELETS**  
CODE: BT + LOCATION



**UPGRADED EPAULET**  
CODE: FM\_LRE



**NAMEPLATE PATCH**  
CODE: 4D\_RUF



**UPGRADED POCKET FLAP**  
CODE: FM\_LRF

LOT #	BADGE TAB - DESCRIPTION
EBT072	LT BLUE
ETB004	SILV TAN, METAL EYELETS
ETB059	DARK GREEN, METAL EYELETS
ETB349	NAVY, METAL EYELETS
ETB007	WHITE, METAL EYELETS
ETB008	NAVY, METAL EYELETS
ETB011	DK NAVY, SEWN EYELETS
ETB026	BLACK, METAL EYELETS
ETB027	SILV TAN, METAL EYELETS
ETB032	DK NAVY, METAL EYELETS
ETB059	Dark Green, Metal Eyelets
ETB349	FR, Navy, Metal Eyelets
ETB058	TWILL, DK GREEN, EYELETS 1.5" APART
ETB062	GREEN, EYELETS 1" APART
ETB351	RB, METAL EYELETS
ETB353	OR, METAL EYELETS
ETB354	TN, METAL EYELETS



PLAIN



BLACK EFBK21



PINK TAN EFQ040



DARK NAVY EF0039



BROWN EFSB23



FOREST GREEN EF0193



PLAIN



BLACK EE0041



PINK TAN EE0042



DARK NAVY EE21DN



BROWN EE22SB



SPRUCE GREEN EE28SG



FOREST GREEN EE0040



# PANT STRIPES AND HEMS

Get a leg up on the competition by adding a distinctive stripe to any pair of pants and attain uniform excellence when coordinating them with our distinctive selection of shirts and shirt trims. The 1" stripes shown here can stand on their own or be teamed with a second layer to create a piggyback stripe. Or, choose bias workwear stripes like the one shown on the brown pant (C., at right), in 1/2" widths.



- A. 1" stripe with second layer  
Code: AS\_OSW\_+ components
- B. 3/4" stripe  
Code: AS\_OSW\_+ component
- C. 1/2" bias stripe  
Code: 3B\_OSW\_+ component

**WE'LL GO TO ANY LENGTH TO HELP YOU ACHIEVE THE LOOK YOU WANT**

Whether it's capris or bermudas, straight lengths or cuffed hems, we'll customize your pants to fit your needs no matter what the climate or fashion demands.

**AVAILABLE HEMS:** Pants will be hemmed to the desired inseam length with the designated hem for that pant. Workwear Outfitters hem pricing rules apply. These must be ordered through a Customer Service Representative.

- A. 12" long Bermuda short | Code: HP\_L12
- B. 15" long - just below the knee | Code: HP\_L15
- C. 23" Capri length - 21" (short) and 25" (long)  
Code: HP\_L23, HP\_L21, HP\_L25
- D. Full length standard hem up to 36" in length.  
No customization codes needed.

# ATTACH POCKETS

ACTIVITY: AP

## ROUTE BOOK POCKET



8 oz. Twill Fabric - Matching all same weight pant styles

LOT #	2 DIGIT COLOR CODE	FABRIC WEIGHT	SIZE
EP8L	+ color code	8 oz. Pant	7" x 7.5", no closure



BLACK - BK



WHITE - WH



NAVY - NV

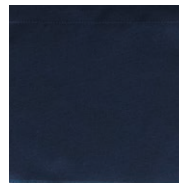

Example of a route book pocket added to a pair of Charcoal pants. See additional color options to the right.

# CUSTOMIZED PANT POCKETS

## ACTIVITY: AP

At Horace Small®, functionality can be built right in at the time you need it.

Custom pockets and placements are available to meet your specific needs. Consult with your Customer Service Representative to find out about your options, or select from the images below.

\*GENERIC IMAGES DETAILS MAY VARY

### FRONT POCKETS

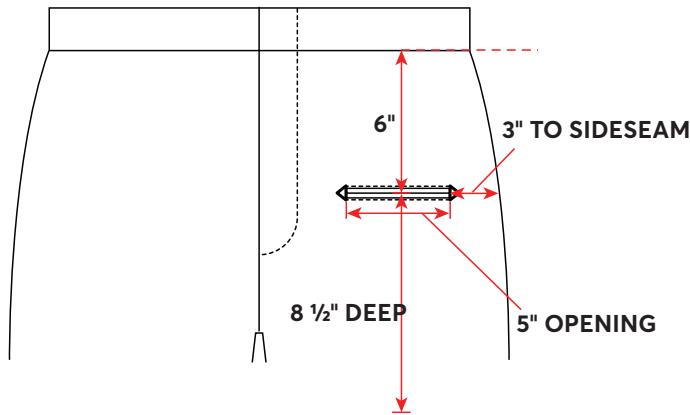

### SIDE SEAM POCKETS

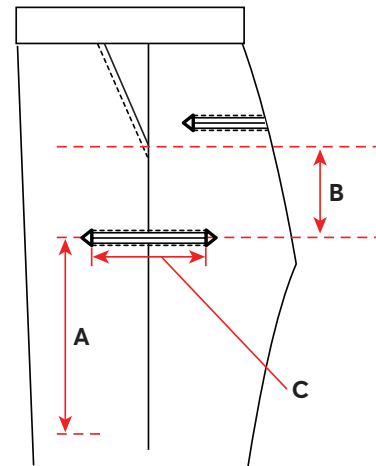

### BACK POCKETS

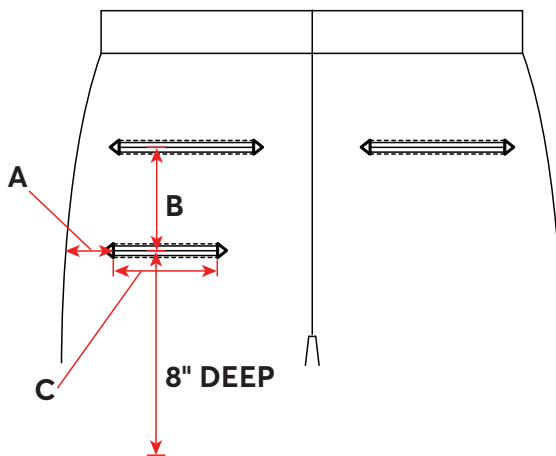

#### BILLY POCKET - SIDE LOCATION (BILLY ON SIDE SEAM)

Use locations RLS and LLS

**A** - 8" Deep

**B** - 3 1/2" Below front quarter top pocket

**C** - 3 1/2" Opening

#### ROUTE POCKET (INTERNAL POCKET)

Use locations RLS and LLS

**A** - 7 1/4" Deep

**B** - 3" Below front quarter top pocket

**C** - 6" Opening

Pencil pockets

Tool pocket

Radio pocket

Cargo pocket with flap

#### BILLY POCKET - SAP LOCATION

Use locations SPL and SPR

**A** - 2" (to side seam)

**B** - 6" Below hip pocket

**C** - 3 1/2" Opening

#### BILLY POCKET - BACK LOCATION

Use locations BLP and BRP

**A** - 1 1/2" (to side seam)

**B** - 3 1/2" Below hip pocket

**C** - 3 1/2" Opening



# TROUSER STRIPES

ACTIVITY: AS

Add a distinctive stripe to any pair of trousers and attain uniform excellence when coordinating them with our selection of shirts and shirt trims. Choose from 3 widths of trims shown below for your specific uniform needs.



1/2" STRIPE

3/4" STRIPE

1" STRIPE

## TROUSER STRIPE COLORS



BLACK

ES34BK 3/4"  
ES01BK 1"



BROWN

ES01BR 1"



CHARCOAL GREY

ES0552 1"



DARK NAVY

ES0084 1/2"



FLORIDA GREY

ES0252 1/2"  
ES0282 3/4"



FRENCH BLUE

ES12FB 1/2"



LAPIS BLUE

ES0060 1/2"



SILVER TAN

ES12ST 1/2"  
ES01ST 1"



YELLOW GOLD

ES01YG 1"

## TROUSER STRIPE & BRAID WIDTHS (shown actual size)



1/2"

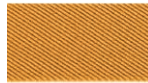

3/4"



1"

## NYLA TWIST BRAIDS ACTIVITY: AN



BLACK

EN0013 1/2"  
EN0014 1"



ROYAL BLUE

EN0028 1/2"



RED

EN0041 1"



GOLD

EN0022 1/2"



GREY

EN0025 1/2"



# ADDITIONAL CUSTOMIZATION OPTIONS

There are many additional customization options and services that we offer our customers. Many of these are not detailed in this catalog and are listed here for your consideration. Your Customer Service Representative can supply you with additional information on any of these options.

ACTIVITY CODE	OPTION NAME
2C	Replace Buttons - Metal Options
2I	Change Sleeve length
AA	Blank ID Label
AL	Add Sewn Label
AR	Add Buttons & Button hole
AV	Attach Hook and Loop
AP	Attach Radio Pocket
AZ	Attach Zipper - (Pants & Coverall Leg, Shirt Placket)
BT	Badge Tab
CU	Attach Knit Cuffs
EV	Sewn Eyelets
IM	Attach ID Chip - (Customer Supplied)
KC	Replace Buttons - Plastic Options
LD	Cut & Hem Bottom of Garment
LT	Lintrak - Silicone Crease - (Horace Small Only)
RM	Remove Item (Buttons, Zippers, Epaulets, Emblems, Labels)
SE	Reinforce Metal Button
SK	Silk-Screen Logo
SL	Silk-Screen Lettering
SP	Sew Locations Closed
TM	Apply Heat TR Logo/Emblem
ZM	Attach Maternity Knit Panel (See page 38)
ZZ	Attach Heatseal ID Label



# BUTTONS

## ACTIVITY: KC - CHANGE OUT TO PLASTIC BUTTONS / 2C - CHANGE OUT TO UPGRADED METAL BUTTONS

Looking for better closure? You're bound to get it when choosing from our distinctive collection of buttons. Add a touch of class to any uniform by exchanging existing buttons for upgraded metallic options in different finishes. Add color and zing to a chef's coat by replacing white buttons with color versions. A single upgrade like this will go a long way toward achieving a look that will have your employees proud to be in uniform.

As shown in the images here, consider customizing your garment by changing out **some** of the buttons where possible. One option is to upgrade buttons to gold or silver on the pocket flaps and epaulets of security shirts, allowing the front buttons to remain white. Changing buttons on a basic chef coat can take it from the kitchen to a presentation coat.



### PLASTIC BUTTONS



Pearl  
EB002W - 24L  
EB003W - 30L



Pearl White  
EB004W - 20L



Black  
EB0077 - 19L



Fireball Red  
BG2708



Charcoal  
EB0014 - 30L



White  
EB1139



Red  
EB1440 - 30L



Navy Polished  
EB1505 - 18L  
EB1506 - 14L



Black Stealth  
EB0015 - 24L

### METAL BUTTON



Gold Plain  
EB0078 - 24L



Tortoise  
EB1510 - 14L



White Polished  
EB1038 - 17L  
EB1039 - 13L  
EB1507 - 17L  
EB1508 - 13L



Black  
EBX499 - 30L

### BUTTONS

**METALLIC BUTTONS** - Home Wash or Dry Clean

We can also store and apply customer-supplied buttons. Contact a CSR for more information.

### PUBLIC SAFETY BUTTONS



Buttons are available in sizes shown.

#### POLICE DEPARTMENT



EB0011 - 24L



EB0036 - 24L  
EB0038 - 36L

#### FIRE DEPARTMENT



EB0009 - 24L



EB0013 - 24L

# MATERNITY PANT CUSTOMIZATION OPTION

ACTIVITY CODE: ZM / LOCATION CODE: CMF



**\*NOT SUITED FOR FR APPAREL**

MADE FOR USE WITH:  
**RED KAP DURA-KAP® WOMEN'S  
INDUSTRIAL PANT**

**LOT# PT21 - ALL COLORS**

**HORACE SMALL SENTRY TROUSER  
FOR WOMEN**

**ALL COLORS**

Since most relevant features are cut away from the pant when the maternity version is created, it is recommended to use these basic pant Lot numbers for the most cost effective options. Other base lots can be used when necessary, and may need to be set up as we go.

**MATERNITY PANEL:**

**FABRIC:** 8.3 oz. Stretch Knit

**BLEND:** 65% Rayon, 29% Nylon, 6% Spandex

**CARE:** Home Wash

**COLOR:** Black Only

**CLOSURE:** 1/2" Comfort Elastic all around waist

FOR PANT SIZE	COMPONENT LOT NUMBER	PANEL COLOR
2,4,6	EMPS06	Black only
8,10,12	EMPM12	Black only
14,16	EMPL16	Black only
18,20,+	EMPX20	Black only

## CHANGES/UPGRADES FROM PREVIOUS MATERNITY PANEL:

- Panel is a two piece design that replaces front and back sections of the woven pant
- Two piece construction brings stretch and ease to the back, as there is no woven constructed waistband causing discomfort
- Front panel is longer, so it covers the belly and has enough fabric to expand as the pregnancy moves to full term
- Softer, 1/2" comfort elastic won't constrict or bind
- Heavier, softer, 4-way stretch fabric is comfortable and secure on the body while remaining breathable



(shown on PT21)

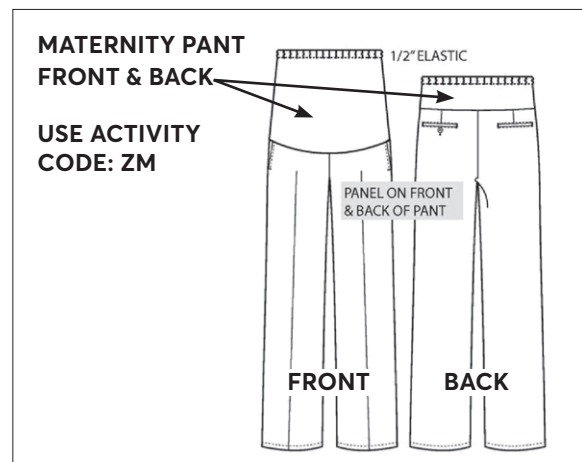

Illustrations are shown on generic garment images.

# PULLING IT ALL TOGETHER

## DECORATIVE TRIMS

From ribbon to soutache or bias trim, there are many available options when it comes to customizing collars, cuffs, and shirt fronts. Just an edge in red can make an image statement that's hard to forget. After all, isn't that the impression we're all trying to make? Shown here are a few of the many possibilities. Over the next several pages, we'll give you a great start to formulating your own ideas as

to how you can take your image to another level! The images on the following pages were created to assist you in visualizing trim placements on a variety of garments. If you have any questions, call your Customer Service Representative at 1.800.733.5271, and they will assist you in placing an order. These images DO NOT show all available options and are not available on all products.



# AUTOMOTIVE SHIRTS / JACKETS



# CHEF COATS

## FABRIC OVERLAYS

Beginning with a corporate color story, build your program by selecting from our assortment of fabric overlay options. One selection used strategically over several items can pull together the look you want, one employee at a time.

We've done our homework to determine which fabrics can be safely applied to others, to ensure against color bleed, crocking, or differential shrinkage. That said, trim and overlay options may change as you decorate different base garments.



# TRIMS

These pages provide images of our trim selection by style and color. Information included with each section will guide you as to the potential uses and wash options.



## SOUTACHE

Our soutache braid is 100% Polyester and can be used on many different garments. It can be used instead of piping without needing to break open a seam or can be used as an accent to work with a fabric overlay.

**METALLIC SOUTACHE** - Dry Clean  
**COLORED SOUTACHE** - Home Wash or Dry Clean

### SUGGESTED PLACEMENTS:

Add to the edge of an overlay or stripe on the collar and/or cuff, or to the edge of a collar/front instead of piping.



Red 1/8" **EHP005**



## IL FRIENDLY SOUTACHE



Red 1/8" **EW3901**



Black 1/8" **EW3902**



## KNIT TRIM

Our knit trim is 100% Polyester and can be washed in a light soil industrial environment. Because it is a knit, it is more flexible and can maneuver around corners on collars and cuffs. Garments customized with knit trim can be industrial laundered, home washed or dry cleaned.

### SUGGESTED PLACEMENTS:

Cuffs, collars and/or fronts of culinary items or aprons, or other industrial launderable service apparel items, such as lab coats or counter coats.

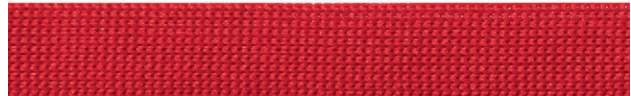

Red 1/2" **EHP041**



## RIBBONS

Our ribbons are 100% Polyester and can be used in a variety of applications. Ribbon colors cannot be changed. Garments customized with ribbon can be dry cleaned, home washed, and light soil washed.



Black/White Check 1/2" **EHP051**



## FABRIC OVERLAYS & BIAS TRIMS

Color swatches below represent many of the fabrics used for customization overlays and bias trims. Overlays and bias trims should match the fabric content of the garment being customized when possible. Washing instructions will not change when a garment is customized with the same fabrics or trims in different colors.

### 65P/35C WORK SHIRT FABRICS/ BIAS TRIM



WS Poplin - Light Grey  
BIAS J86062



WS Poplin - Red  
BIAS J86073 | FABRIC E86073



WS Poplin - Yellow  
BIAS J83726

### 3/4" FABRIC/ BIAS TRIM



4.25 oz. Ripstop - Fused Gold  
BIAS EJ6001

### 1" 2-COLOR STRIPES - IL FRIENDLY WORK SHIRT FABRICS



1" - Black / White  
EJ5911



1" - Orange / White  
EJ5912



1" - Red / White  
EJ5918



1" - Royal Blue / White  
EJ5919



1" - Red / Silver  
EJ5088

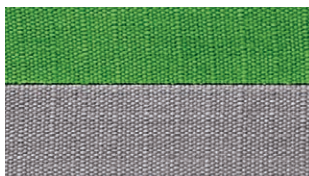

1" - Grey/Green  
EJ5921

## 1" STRIPES

The stripes shown here are straight cut and 1" in width. They are 100% Polyester with a fused backing in order to maintain their shape and eliminate shrinkage.

These stripes can also be used for embroidering a name. This application is home wash and industrial laundry friendly and provides an alternative to name embroidery on an emblem.

### SUGGESTED PLACEMENTS:

Any pant or short side seam. As a name strip for embroidery purposes, placement is usually left or right upper front.

## 1" PANT STRIPE COLORS

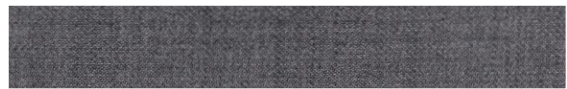

Heather Grey 1" ES01GH

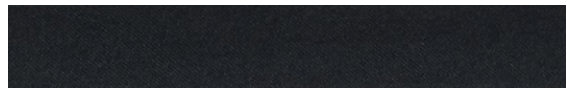

Black 1" ES01BK



Dark Navy 1" ES01DN

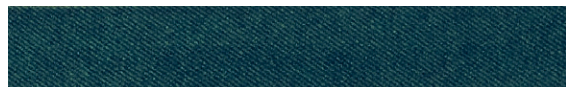

Spruce Green 1" ES01SG



Red 1" ES01RD



Burgundy 1" ES01MR

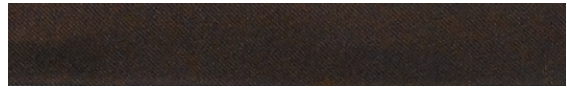

Brown 1" ES01BR



Khaki 1" ES01ST



Royal Blue 1" ES01RB

# DECORATE IT. MODIFY IT. CUSTOMIZE IT.

Contact a Workwear Outfitters Customer  
Service Representative at: 1.800.733.5271



**WORKWEAR  
OUTFITTERS**

